

35 Amp, No Heatsink, Isolated DC/DC Converter

The PQ60033QTA35 PowerQor® Tera quarter-brick converter is a next-generation, board-mountable, isolated, fixed switching frequency DC/DC converter that uses synchronous rectification to achieve extremely high conversion efficiency. The power dissipated by the converter is so low that a heatsink is not required, which saves cost, weight, height, and application effort. All of the power and control components are mounted to the multi-layer PCB substrate with high-yield surface mount technology. Since the PowerQor converter has no explicit thermal connections, it is extremely reliable. The Tera series offers the maximum useable output current for any standard “quarter-brick” module.

PowerQor®



PQ60033QTA35 Module

Operational Features

- Ultra-high efficiency, 92% at half load, above 90% at full rated load current
- Delivers up to 35 amps of output current with minimal derating - no heatsink required
- Wide input voltage range: 35V – 75V, with 100V 100ms input voltage transient withstand
- Fixed frequency switching provides predictable EMI performance
- No minimum load requirement means no preload resistors required

Mechanical Features

- Industry standard quarter-brick pin-out configuration
- Industry standard size: 1.45" x 2.3"
- Total height less than 0.43", permits better airflow and smaller card pitch
- Total weight: 42 grams (1.5 oz.), lower mass greatly reduces vibration and shock problems

Control Features

- On/Off control referenced to input side (positive and negative logic options are available)
- Remote sense for the output voltage compensates for output distribution drops
- Output voltage trim permits custom voltages and voltage margining

Protection Features

- Input under-voltage lockout disables converter at low input voltage conditions
- Output current limit and short circuit protection protects converter from excessive load current or short circuits
- Output over-voltage protection protects load from damaging voltages
- Thermal shutdown protects converter from abnormal environmental conditions

Safety Features

- 2000V, 10 MΩ input-to-output isolation provides input/output ground separation
- UL/cUL 60950 recognized (US & Canada), basic insulation rating
- TUV certified to EN60950
- Meets 72/23/EEC and 93/68/EEC directives which facilitates CE Marking in user's end product
- Board and plastic components meet UL94V-0 flammability requirements

MECHANICAL DIAGRAM

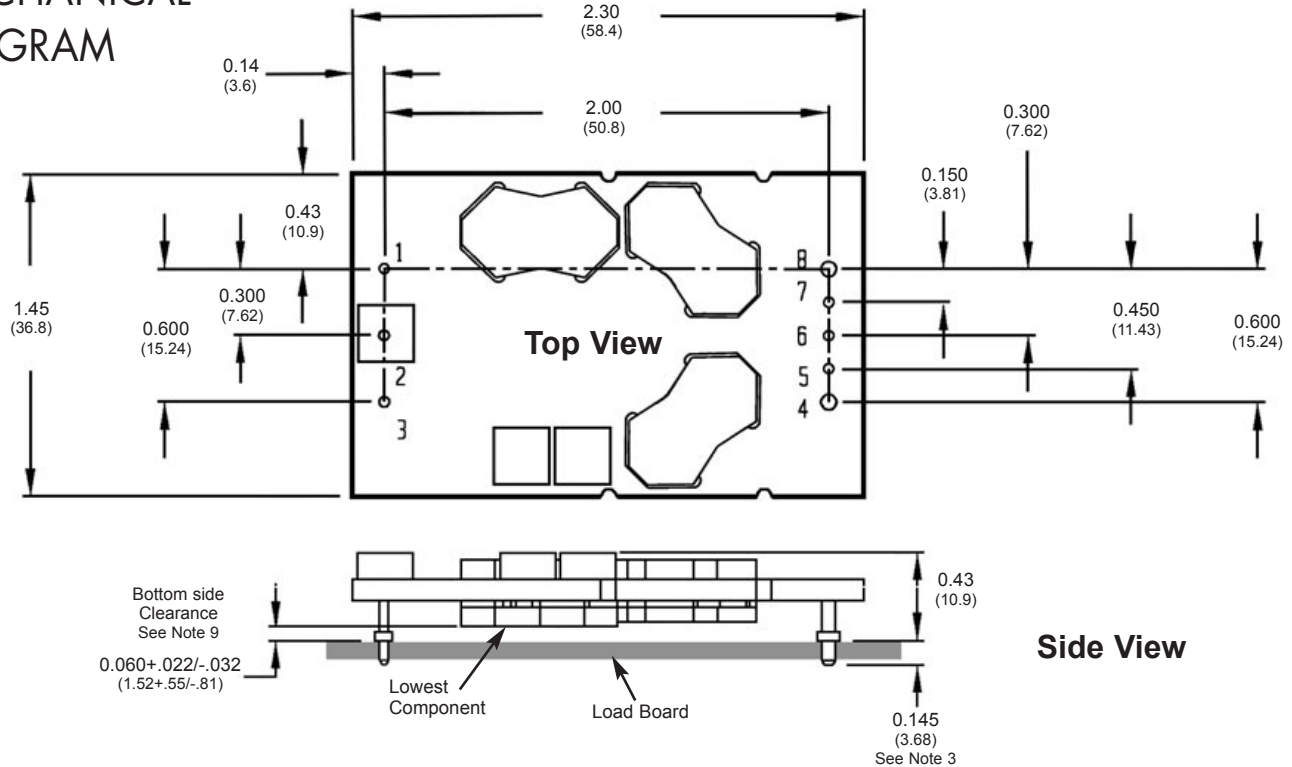

NOTES

- 1) Pins 1-3, 5-7 are 0.040" (1.02mm) diameter with 0.080" (2.03 mm) diameter standoff shoulders.
- 2) Pins 4 and 8 are 0.062" (1.57 mm) diameter with 0.100" (2.54 mm) diameter standoff shoulders.
- 3) Other pin extension lengths available. Recommended pin length is 0.03" (0.76mm) greater than the PCB thickness.
- 4) All Pins: Material - Copper Alloy
Finish - Tin/Lead over Nickel plate
- 5) Undimensioned components are shown for visual reference only.
- 6) All dimensions in inches (mm)
Tolerances: x.xx +/-0.02 in. (x.x +/-0.5mm)
x.xxx +/-0.010 in. (x.xx +/-0.25mm)
- 7) Weight: 1.5 oz. (42 g) typical
- 8) Workmanship: Meets or exceeds IPC-A-610C Class II
- 9) UL/TUV standards require a clearance greater than 0.04" (1.02mm) between input and output for Basic insulation. This issue should be considered if any copper traces are on the top side of the user's board. Note that the ferrite cores are considered part of the input/primary circuit.

PIN CONNECTIONS

Pin No.	Name	Function
1	Vin(+)	Positive input voltage
2	ON/OFF	TTL input to turn converter on and off, referenced to Vin(-), with internal pull up.
3	Vin(-)	Negative input voltage
4	Vout(-)	Negative output voltage
5	SENSE(-)	Negative remote sense ¹
6	TRIM	Output voltage trim ²
7	SENSE(+)	Positive remote sense ³
8	Vout(+)	Positive output voltage

Notes:

1. Pin 5 must be connected to Vout(-).
2. Leave Pin 6 open for nominal output voltage.
3. Pin 7 must be connected to Vout(+).



Technical Specification

**Quarter
Brick**

48V_{in} 3.3V_{out} 35A

PQ60033QTA35 ELECTRICAL CHARACTERISTICS

T_A=25°C, airflow rate=300 LFM, V_{in}=48Vdc unless otherwise noted; full operating temperature range is -40°C to +100°C ambient temperature with appropriate power derating. Specifications subject to change without notice.

Parameter	Min.	Typ.	Max.	Units	Notes & Conditions
ABSOLUTE MAXIMUM RATINGS					
Input Voltage					
Non-Operating			100	V	continuous
Operating			80	V	continuous
Operating Transient Protection			100	V	100ms transient; Figure 17
Isolation Voltage (input to output)			2000	V	Basic level, Pollution Degree 2
Operating Temperature	-40		100	°C	
Storage Temperature	-55		125	°C	
Voltage at ON/OFF input pin	-2		18	V	
INPUT CHARACTERISTICS					
Operating Input Voltage Range	35	48	75	V	
Input Under-Voltage Lockout					
Turn-On Voltage Threshold	32	33	34	V	
Turn-Off Voltage Threshold	28.5	29.5	30.5	V	
Lockout Hysteresis Voltage	2.5	3.5	4.5	V	
Maximum Input Current			6.0	A	100% Load, 35 V _{in} , trim up, in current limit
No-Load Input Current		70	120	mA	
Disabled Input Current		1.6	3	mA	
Inrush Current Transient Rating		0.01		A ² s	
Response to Input Transient		150		mV	1000V/ms input transient; Figure 17
Input Reflected-Ripple Current		7		mA	P-P thru 10µH inductor; Figs. 13 & 15
Recommended Input Fuse			7	A	fast blow external fuse recommended
Input Filter Component Values (C1\1\C2)		1\5\3		µF\µH\µF	internal values, see Figure E
Recommended External Input Capacitance	33	47		µF	see Figure 13
OUTPUT CHARACTERISTICS					
Output Voltage Set Point	3.267	3.300	3.333	V	
Output Voltage Regulation					
Over Line		±0.05 \ 2	±0.15 \ 5	%\mV	
Over Load		±0.05 \ 2	±0.15 \ 5	%\mV	
Over Temperature		±17	±50	mV	
Total Output Voltage Range	3.207		3.393	V	over sample, line, load, temperature & life
Output Voltage Ripple and Noise					500MHz bandwidth; Fig. 13 & 16
Peak-to-Peak		50	100	mV	Full Load, see Figures 13 & 16
RMS		10	20	mV	Full Load, see Figures 13 & 16
Operating Output Current Range	0		35	A	
Output DC Current-Limit Inception	38	42	46	A	Output Voltage 10% Low
Output DC Current-Limit Shutdown Voltage		1.64		V	
Back-Drive Current Limit while Enabled	0.5	1.3	2.5	A	Max negative current drawn from output
Back-Drive Current Limit while Disabled	0	10	50	mA	Max negative current drawn from output
Maximum Output Capacitance			24,000	µF	3.3V _{out} at 35A Resistive Load
DYNAMIC CHARACTERISTICS					
Input Voltage Ripple Rejection		60		dB	120 Hz; Fig. 20
Output Voltage during Load Current Transient					
Step Change in Output Current (0.1A/µs)		80		mV	50% to 75% to 50% lout max; Figure 11
Step Change in Output Current (1A/µs)		200		mV	50% to 75% to 50% lout max; Figure 12
Settling Time		400		µs	to within 1% V _{out} nom
Turn-On Transient					
Turn-On Time		4	8	ms	Full load, V _{out} =90% nom.; Figs. 9 & 10
Start-Up Inhibit Time	180	200	215	ms	-40°C to +125°C; Figure F
Output Voltage Overshoot		0		%	10,000 µF load capacitance, lout = 0A
EFFICIENCY					
100% Load	88.5	90.5		%	Figures 1 - 4
50% Load	90	92		%	Figures 1 - 4
TEMPERATURE LIMITS FOR POWER DERATING CURVES					
Semiconductor Junction Temperature			125	°C	Package rated to 150°C
Board Temperature			125	°C	UL rated max operating temp 130°C
Transformer Temperature			125	°C	See Figures 5 - 8 for derating curves
ISOLATION CHARACTERISTICS					
Isolation Voltage		2000		V	
Isolation Resistance		10		MΩ	
Isolation Capacitance			470	pF	

ELECTRICAL CHARACTERISTICS (Continued)

Parameter	Min.	Typ.	Max.	Units	Notes & Conditions
FEATURE CHARACTERISTICS					
Switching Frequency	220	240	260	kHz	
ON/OFF Control (Option P)					
Off-State Voltage	-2		0.8	V	
On-State Voltage	2.4		18	V	
ON/OFF Control (Option N)					
Off-State Voltage	2.4		18	V	
On-State Voltage	-2		0.8	V	
ON/OFF Control (Either Option)					Figures A, B
Pull-Up Voltage		V _{in} /6.5	9.2	V	
Pull-Up Resistance		40		kΩ	
Output Voltage Trim Range	-20		+10	%	Measured across Pins 8 & 4; Figure C
Output Voltage Remote Sense Range			+10	%	Measured across Pins 8 & 4
Output Over-Voltage Protection	117	122	127	%	Over full temp range; % of nominal V _{out}
Over-Temperature Shutdown		125		°C	Average PCB Temperature
Over-Temperature Shutdown Restart Hysteresis		10		°C	
RELIABILITY CHARACTERISTICS					
Calculated MTBF		2.1		10 ⁶ Hrs.	Telcordia TR-NWT-000332; 80% load, 300LFM, 40°C T _a
Calculated MTBF		1.75		10 ⁶ Hrs.	MIL-HDBK-217F; 80% load, 300LFM, 40°C T _a
Demonstrated MTBF		TBD		10 ⁶ Hrs.	Field demonstrated MTBF

STANDARDS COMPLIANCE

Parameter	Notes
STANDARDS COMPLIANCE	
UL/cUL 60950	File # E194341, Basic insulation & pollution degree 2
EN60950	Certified by TÜV
72/23/EEC	
93/68/EEC	
Needle Flame Test (IEC 695-2-2)	test on entire assembly; board & plastic components UL94V-0 compliant
IEC 61000-4-2	ESD test, 8kV - NP, 15kV air - NP
GR-1089-CORE	Section 7 - electrical safety, Section 9 - bonding/grounding
Telcordia (Bellcore) GR-513	

- An external input fuse must always be used to meet these safety requirements

QUALIFICATION TESTING

Parameter	# Units	Test Conditions
QUALIFICATION TESTING		
Life Test	32	95% rated V _{in} and load, units at derating point, 1000 hours
Vibration	5	10-55Hz sweep, 0.060" total excursion, 1 min./sweep, 120 sweeps for 3 axis
Mechanical Shock	5	100g minimum, 2 drops in x and y axis, 1 drop in z axis
Temperature Cycling	10	-40°C to 100°C, unit temp. ramp 15°C/min., 500 cycles
Power/Thermal Cycling	5	T _{operating} = min to max, V _{in} = min to max, full load, 100 cycles
Design Marginality	5	T _{min} -10°C to T _{max} +10°C, 5°C steps, V _{in} = min to max, 0-105% load
Humidity	5	85°C, 85% RH, 1000 hours, 2 minutes on and 6 hours off
Solderability	15 pins	MIL-STD-883, method 2003

- Extensive characterization testing of all SynQor products and manufacturing processes is performed to ensure that we supply robust, reliable product. Contact factory for more information about Proof of Design and Proof of Manufacturing processes.

OPTIONS

SynQor provides various options for Logic Sense, Pin Length and Feature Set for this family of DC/DC converters. Please consult the last page of this specification sheet for information on available options.

Performance Curves

Quarter Brick **48V_{in} 3.3V_{out} 35A**

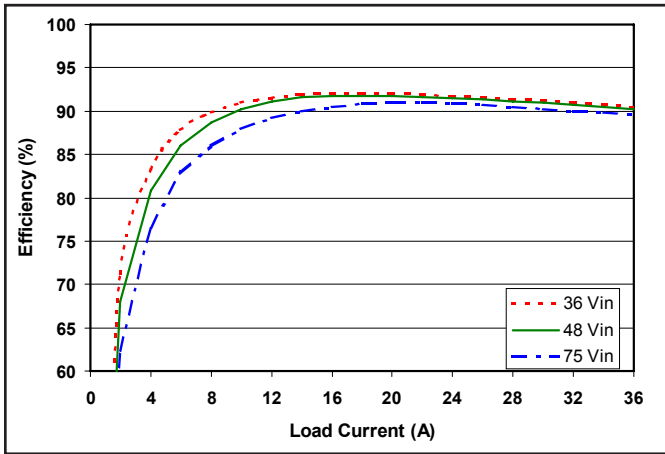

Figure 1: Efficiency at nominal output voltage vs. load current for minimum, nominal, and maximum input voltage at 25°C.

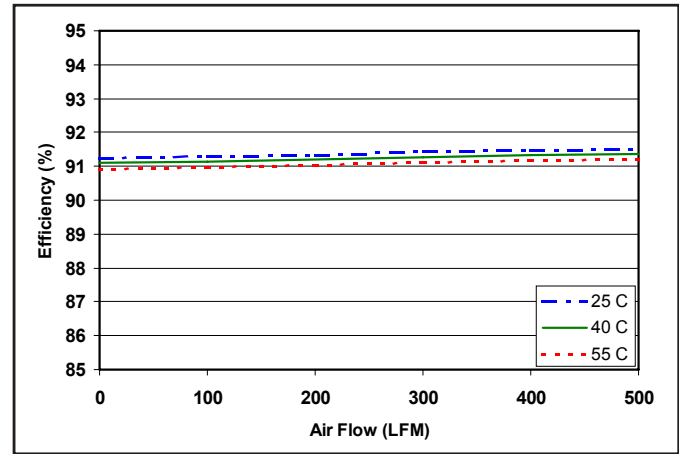

Figure 2: Efficiency at nominal output voltage and 60% rated power vs. airflow rate for ambient air temperatures of 25°C, 40°C, and 55°C (nominal input voltage).

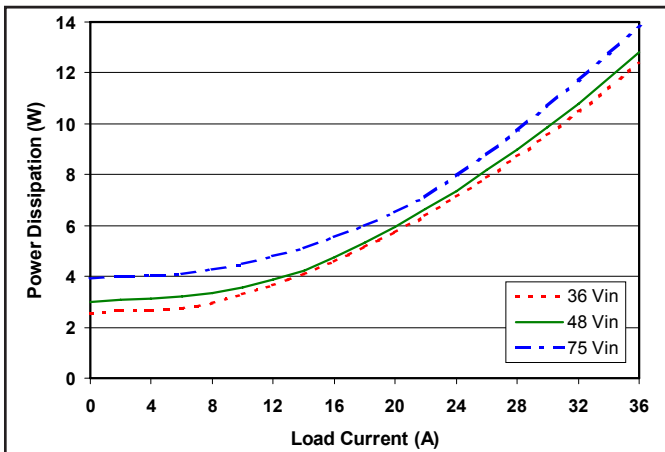

Figure 3: Power dissipation at nominal output voltage vs. load current for minimum, nominal, and maximum input voltage at 25°C.

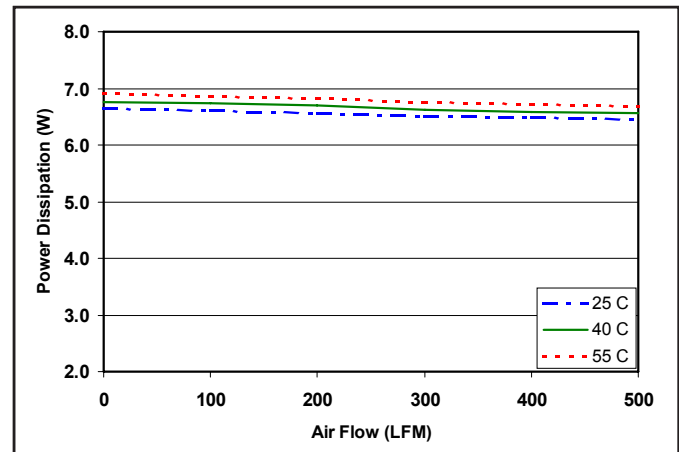

Figure 4: Power dissipation at nominal output voltage and 60% rated power vs. airflow rate for ambient air temperatures of 25°C, 40°C, and 55°C (nominal input voltage).

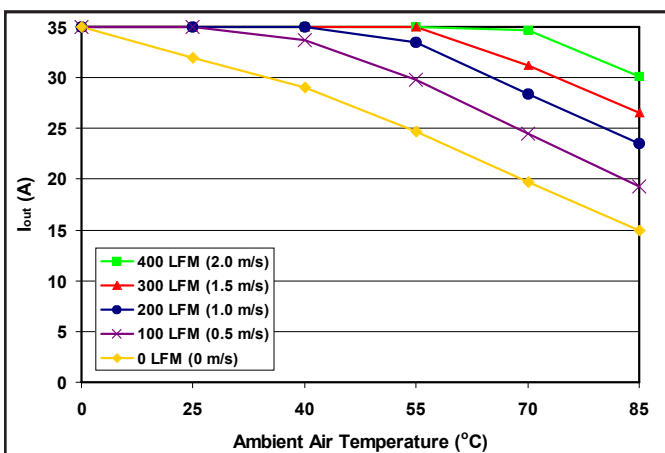

Figure 5: Maximum output power derating curves vs. ambient air temperature for airflow rates of 0 LFM through 400 LFM with air flowing across the converter from pin 3 to pin 1 (nominal input voltage).

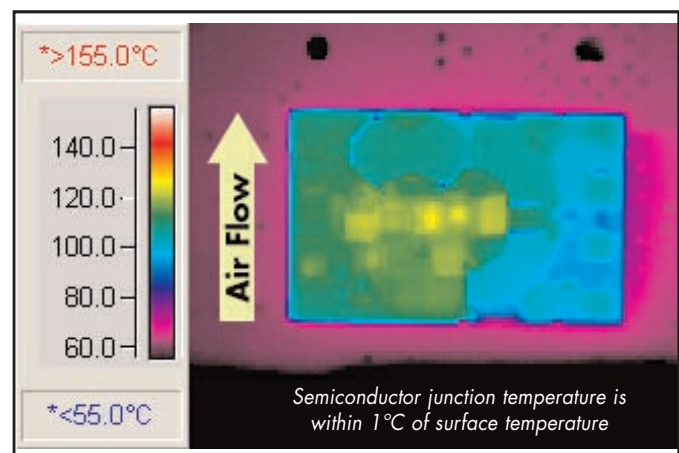

Figure 6: Thermal plot of converter at 34 amp load current with 55°C air flowing at the rate of 200 LFM. Air is flowing across the converter from pin 3 to pin 1 (nominal input voltage).

Performance Curves

Quarter
Brick

48V_{in} 3.3V_{out} 35A

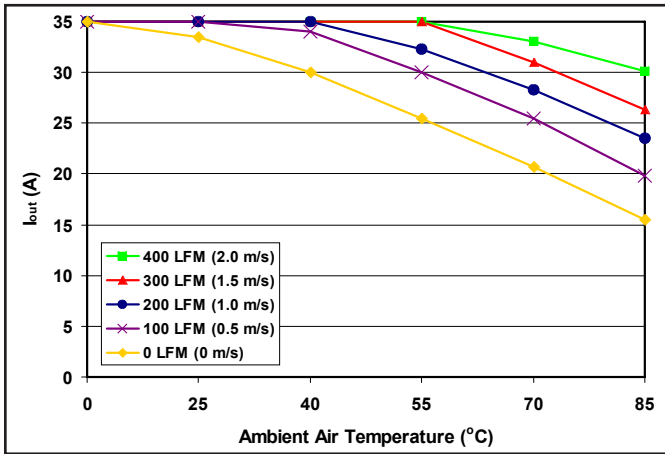

Figure 7: Maximum output power derating curves vs. ambient air temperature for airflow rates of 0 LFM through 400 LFM with air flowing lengthwise from input to output (nominal input voltage).

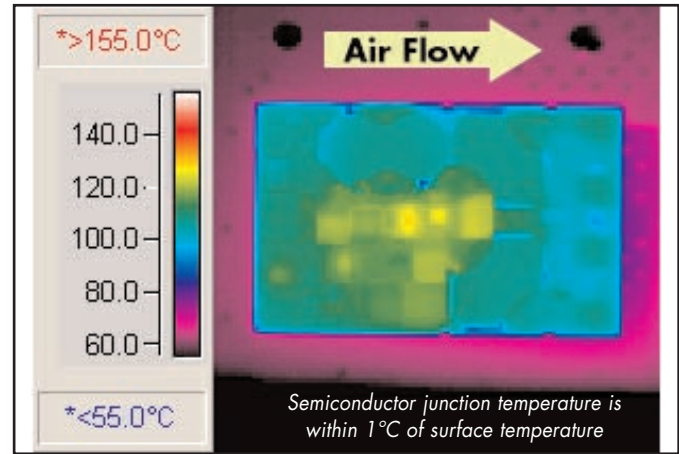

Figure 8: Thermal plot of converter at 32 amp load current with 55°C air flowing at the rate of 200 LFM. Air is flowing lengthwise from input to output (nominal input voltage).

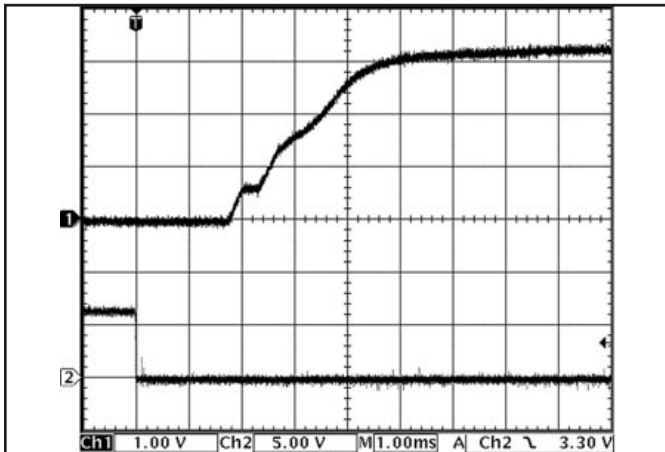

Figure 9: Turn-on transient at full rated load (resistive load) (2 ms/div)
Ch 1: V_{out} (1V/div)
Ch 2: ON/OFF input (5V/div)

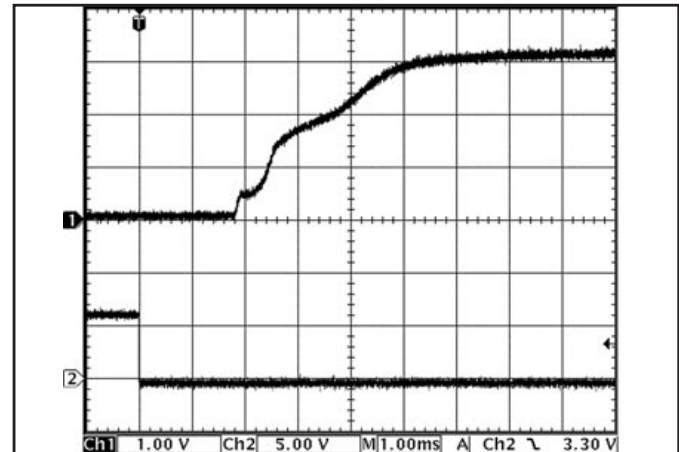

Figure 10: Turn-on transient at zero load current (2 ms/div).
Ch 1: V_{out} (1V/div)
Ch 2: ON/OFF input (5V/div)

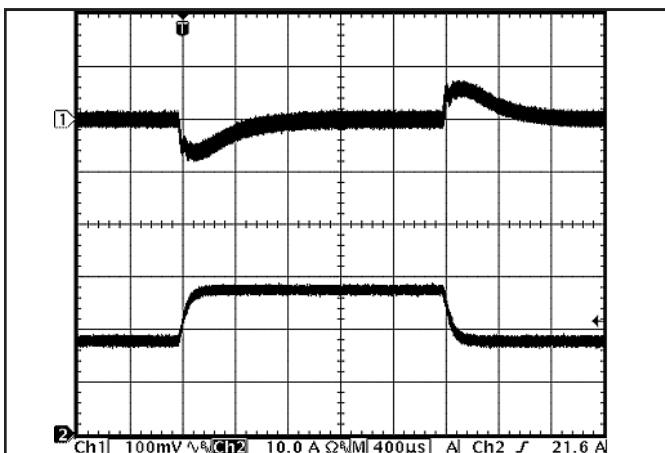

Figure 11: Output voltage response to step-change in load current (50%-75%-50% of I_{out}(max); dI/dt = 0.1A/μs). Load cap: 10μF, 100 mΩ ESR tantalum capacitor and 1μF ceramic capacitor. Ch 1: V_{out} (100mV/div), Ch 2: I_{out} (10A/div).

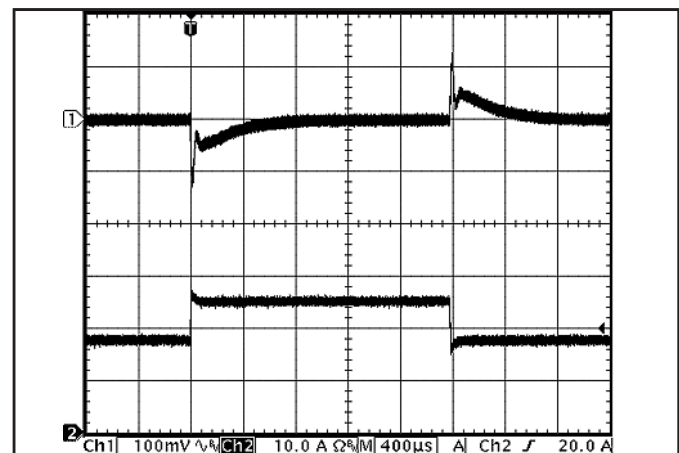

Figure 12: Output voltage response to step-change in load current (50%-75%-50% of I_{out}(max); dI/dt = 1A/μs). Load cap: 470μF, 30 mΩ ESR tantalum capacitor and 1μF ceramic cap. Ch 1: V_{out} (100mV/div), Ch 2: I_{out} (10A/div).

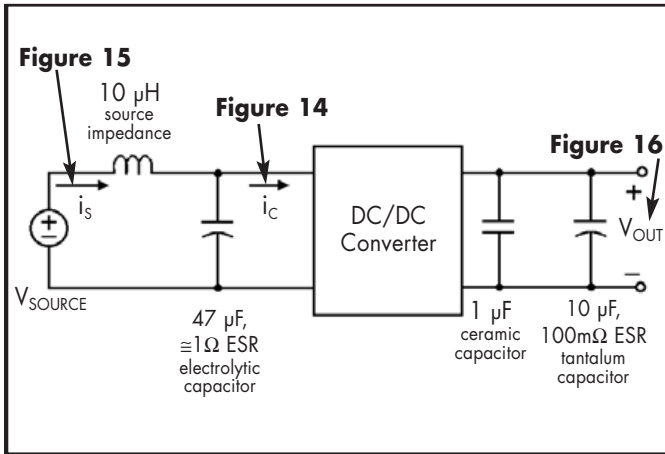

Figure 13: Test set-up diagram showing measurement points for Input Terminal Ripple Current (Figure 14), Input Reflected Ripple Current (Figure 15) and Output Voltage Ripple (Figure 16).

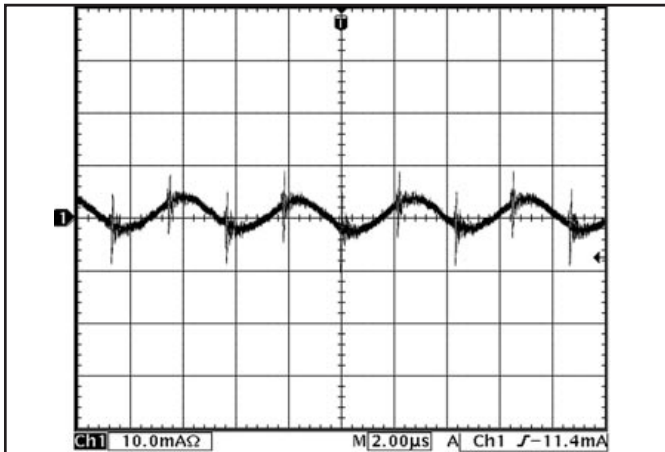

Figure 15: Input reflected ripple current, i_s , through a $10\ \mu\text{H}$ source inductor at nominal input voltage and rated load current (10 mA/div). See Figure 13.

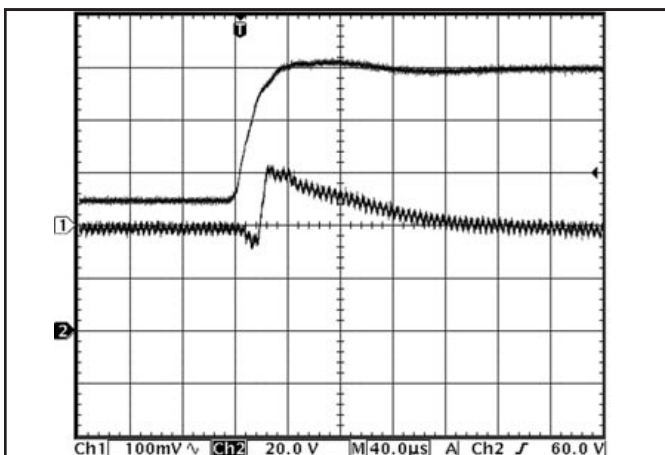

Figure 17: Output voltage response to step-change in input voltage (50V to 100V in $40\ \mu\text{s}$). Load cap: $10\ \mu\text{F}$, $100\ \text{m}\Omega$ ESR tantalum capacitor and $1\ \mu\text{F}$ ceramic cap. Ch 1: V_{out} (100mV/div), Ch 2: V_{in} (20V/div).

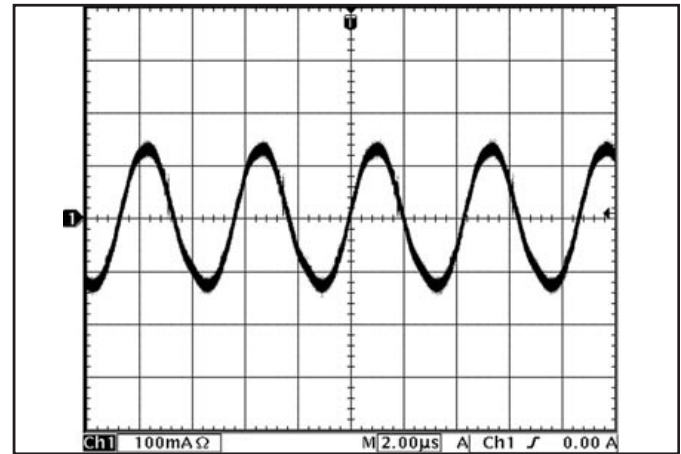

Figure 14: Input Terminal Ripple Current, i_c , at full rated output current and nominal input voltage with $10\ \mu\text{H}$ source impedance and $47\ \mu\text{F}$ electrolytic capacitor (100 mA/div). See Figure 13.

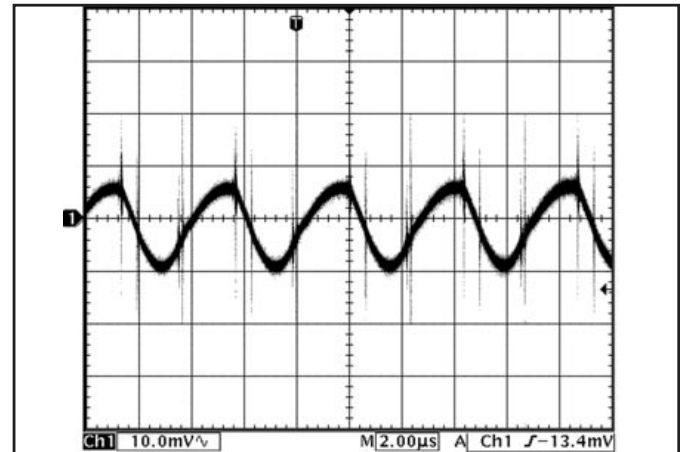

Figure 16: Output voltage ripple at nominal input voltage and rated load current (10 mV/div). Load capacitance: $1\ \mu\text{F}$ ceramic capacitor and $10\ \mu\text{F}$ tantalum capacitor. Bandwidth: 500 MHz. See Figure 13.

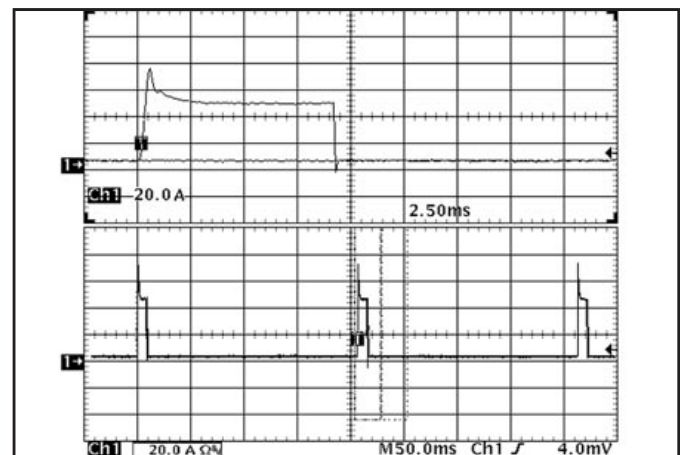

Figure 18: Load current (20A/div) as a function of time when the converter attempts to turn on into a $1\ \text{m}\Omega$ short circuit. Bottom trace (2ms/div) is an expansion of the on-time portion of the top trace.

Performance Curves

Quarter Brick **48V_{in} 3.3V_{out} 35A**

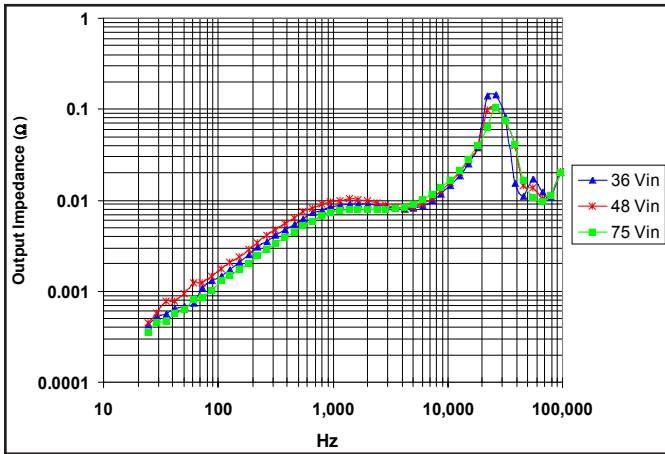

Figure 19: Magnitude of incremental output impedance ($Z_{out} = v_{out}/i_{out}$) for minimum, nominal, and maximum input voltage at full rated power.

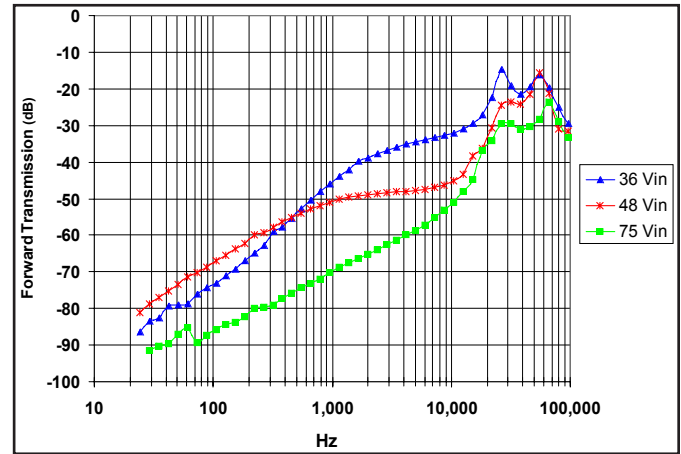

Figure 20: Magnitude of incremental forward transmission ($FT = v_{out}/v_{in}$) for minimum, nominal, and maximum input voltage at full rated power.

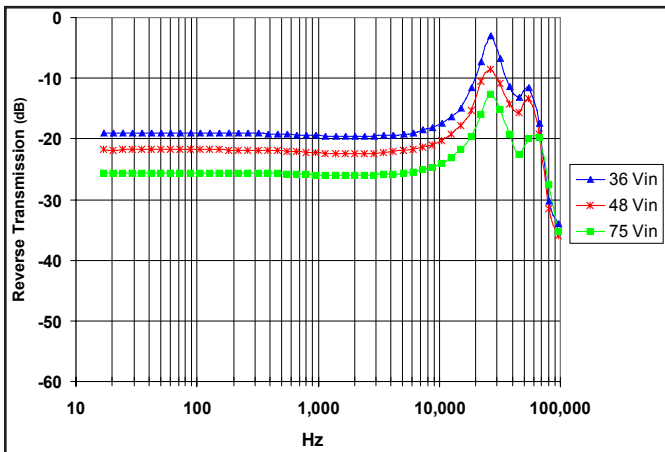

Figure 21: Magnitude of incremental reverse transmission ($RT = i_{in}/i_{out}$) for minimum, nominal, and maximum input voltage at full rated power.

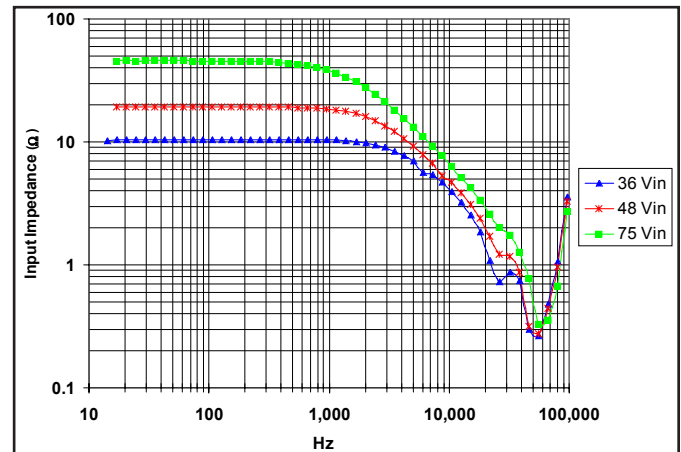

Figure 22: Magnitude of incremental input impedance ($Z_{in} = v_{in}/i_{in}$) for minimum, nominal, and maximum input voltage at full rated power.

BASIC OPERATION AND FEATURES

The PowerQor series converter uses a two-stage power circuit topology. The first stage is a buck-converter that keeps the output voltage constant over variations in line, load, and temperature. The second stage uses a transformer to provide the functions of input/output isolation and voltage step-down to achieve the low output voltage required.

Both the first stage and the second stage switch at a fixed frequency for predictable EMI performance. Rectification of the transformer's output is accomplished with synchronous rectifiers. These devices, which are MOSFETs with a very low on-state resistance, dissipate far less energy than Schottky diodes. This is the primary reason that the PowerQor converter has such high efficiency, even at very low output voltages and very high output currents.

Dissipation throughout the converter is so low that it does not require a heatsink for operation. Since a heatsink is not required, the PowerQor converter does not need a metal baseplate or potting material to help conduct the dissipated energy to the heatsink. The PowerQor converter can thus be built more simply and reliably using high yield surface mount techniques on a PCB substrate.

The PowerQor series of half-brick and quarter-brick converters uses the industry standard footprint and pin-out configuration.

CONTROL FEATURES

REMOTE ON/OFF (Pin 2): The ON/OFF input, Pin 2, permits the user to control when the converter is on or off. This input is referenced to the return terminal of the input bus, Vin(-). There are two versions of the converter that differ by the sense of the logic used for the ON/OFF input.

In the positive logic version, the ON/OFF input is active high (meaning that a high turns the converter on). In the negative logic version, the ON/OFF signal is active low (meaning that a low turns the converter on). Figure A details five possible circuits for driving the ON/OFF pin. Figure B is a detailed look of the internal ON/OFF circuitry.

REMOTE SENSE(+) (Pins 7 and 5): The SENSE(±) inputs correct for voltage drops along the conductors that connect the converter's output pins to the load.

Pin 7 should be connected to Vout(+) and Pin 5 should be connected to Vout(-) at the point on the board where regulation is desired. A remote connection at the load can adjust for a voltage drop only as large as that specified in this datasheet, that is

$$\frac{[V_{out(+)} - V_{out(-)}] - [SENSE(+) - SENSE(-)]}{Sense\ Range\ \% \times V_{out}} \leq$$

Pins 7 and 5 must be connected for proper regulation of the output voltage. If these connections are not made, the converter will deliver an output voltage that is slightly lower than its specified value.

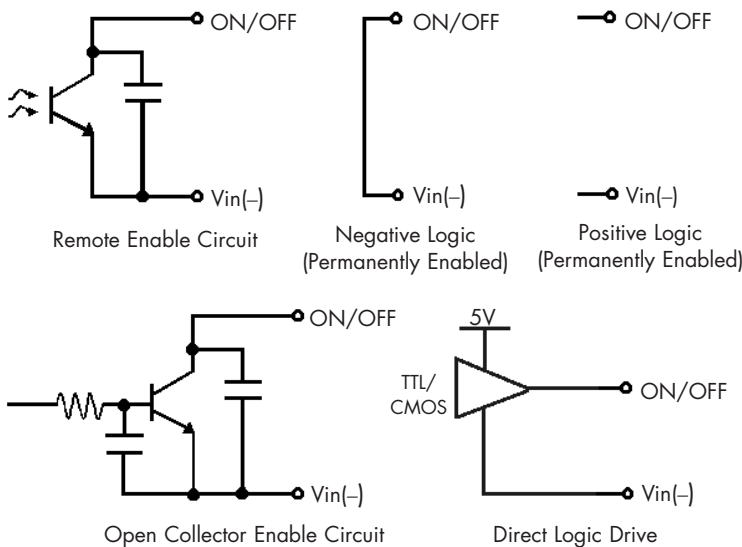

Figure A: Various circuits for driving the ON/OFF pin.

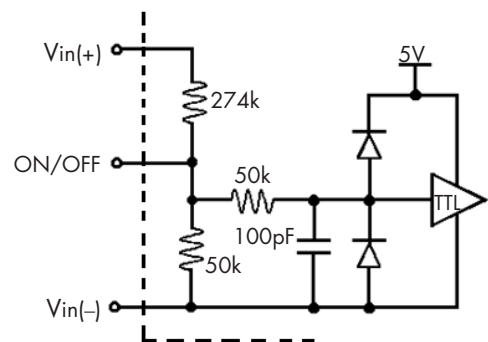

Figure B: Internal ON/OFF pin circuitry

Note: the output over-voltage protection circuit senses the voltage across the output (pins 8 and 4) to determine when it should trigger, not the voltage across the converter's sense leads (pins 7 and 5). Therefore, the resistive drop on the board should be small enough so that output OVP does not trigger, even during load transients.

OUTPUT VOLTAGE TRIM (Pin 6): The TRIM input permits the user to adjust the output voltage across the sense leads up or down according to the trim range specifications.

To decrease the output voltage, the user should connect a resistor between Pin 6 and Pin 5 (SENSE(-) input). For a desired decrease of the nominal output voltage, the value of the resistor should be

$$R_{\text{trim-down}} = \left(\frac{511}{\Delta\%} \right) - 10.22 \text{ (k}\Omega\text{)}$$

where

$$\Delta\% = \left(\frac{V_{\text{nominal}} - V_{\text{desired}}}{V_{\text{nominal}}} \right) \times 100\%$$

To increase the output voltage, the user should connect a resistor between Pin 6 and Pin 7 (SENSE(+) input). For a desired increase of the nominal output voltage, the value of the resistor should be

$$R_{\text{trim-up}} = \left(\frac{5.11 V_{\text{OUT}}(100+\Delta\%)}{1.225\Delta\%} - \frac{511}{\Delta\%} - 10.22 \right) \text{ (k}\Omega\text{)}$$

where

$$V_{\text{OUT}} = \text{Nominal Output Voltage}$$

Figure C graphs the relationship between the trim resistor value and R_{trim-up} and R_{trim-down}, showing the total range the output voltage can be trimmed up or down.

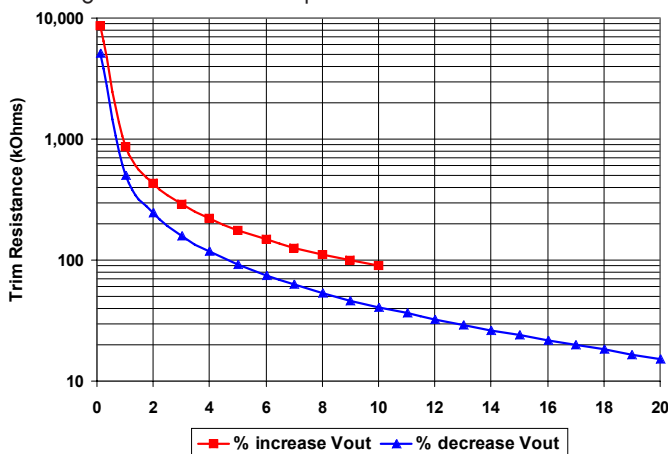

Figure C: Trim Graph for 3.3V_{out} module

Note: the TRIM feature does not affect the voltage at which the output over-voltage protection circuit is triggered. Trimming the output voltage too high may cause the over-voltage protection circuit to engage, particularly during transients.

It is not necessary for the user to add capacitance at the Trim pin. The node is internally bypassed to eliminate noise.

Total DC Variation of V_{out}: For the converter to meet its full specifications, the maximum variation of the DC value of V_{out}, due to both trimming and remote load voltage drops, should not be greater than that specified for the output voltage trim range.

PROTECTION FEATURES

Input Under-Voltage Lockout: The converter is designed to turn off when the input voltage is too low, helping avoid an input system instability problem, described in more detail in the application note titled "Input System Instability". The lockout circuitry is a comparator with DC hysteresis. When the input voltage is rising, it must exceed the typical Turn-On Voltage Threshold value (listed on the specification page) before the converter will turn on. Once the converter is on, the input voltage must fall below the typical Turn-Off Voltage Threshold value before the converter will turn off.

Output Current Limit: The maximum current limit remains constant as the output voltage drops. However, once the impedance of the short across the output is small enough to make the output voltage drop below the specified Output DC Current-Limit Shutdown Voltage, the converter turns off.

The converter then enters a "hiccup mode" where it repeatedly turns on and off at a 5 Hz (nominal) frequency with a 5% duty cycle until the short circuit condition is removed. This prevents excessive heating of the converter or the load board.

Output Over-Voltage Limit: If the voltage across the output pins exceeds the Output Over-Voltage Protection threshold, the converter will immediately stop switching. This prevents damage to the load circuit due to 1) excessive series resistance in output current path from converter output pins to sense point, 2) a release of a short-circuit condition, or 3) a release of a current limit condition. Load capacitance determines exactly how high the output voltage will rise in response to these conditions. After 200 ms the converter will automatically restart.

Over-Temperature Shutdown: A temperature sensor on the converter senses the average temperature of the module. The thermal shutdown circuit is designed to turn the converter off when the temperature at the sensed location reaches the

Over-Temperature Shutdown value. It will allow the converter to turn on again when the temperature of the sensed location falls by the amount of the Over-Temperature Shutdown Restart Hysteresis value.

More detailed information is available in the application note titled "EMI Characteristics" on the SynQor website.

APPLICATION CONSIDERATIONS

Input System Instability: This condition can occur because any DC/DC converter appears incrementally as a negative resistance load. A detailed application note titled "Input System Instability" is available on the SynQor web site (www.synqor.com) which provides an understanding of why this instability arises, and shows the preferred solution for correcting it.

Application Circuits: Figure D below provides a typical circuit diagram which details the input filtering and voltage trimming.

Input Filtering and External Capacitance: Figure E below provides a diagram showing the internal input filter components. This filter dramatically reduces input terminal ripple current, which otherwise could exceed the rating of an external electrolytic input capacitor. The recommended external input capacitance is specified in the "Input Characteristics" section.

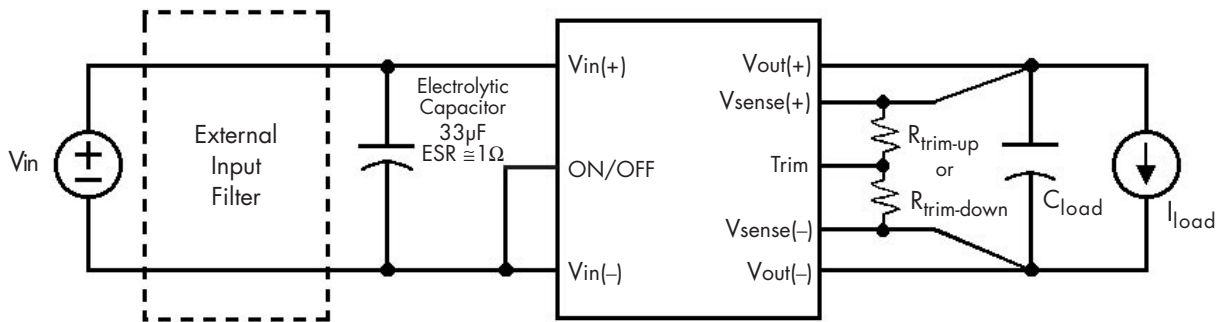

Figure D: Typical application circuit (negative logic unit, permanently enabled).

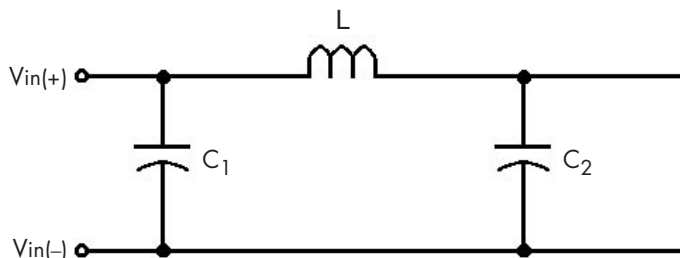

Figure E: Internal Input Filter Diagram (component values listed on page 3).

Startup Inhibit Period: The Startup Inhibit Period ensures that the converter will remain off for at least 200ms when it is shut down for any reason. When an output short is present, this generates a 5Hz "hiccup mode," which prevents the converter from overheating. In all, there are seven ways that the converter can be shut down, initiating a Startup Inhibit Period:

- Input Under-Voltage Lockout
- Input Over-Voltage Shutdown (not present in Quarter-brick)
- Output Over-Voltage Protection
- Over Temperature Shutdown
- Current Limit
- Short Circuit Protection
- Turned off by the ON/OFF input

Figure F shows three turn-on scenarios, where a Startup Inhibit Period is initiated at t_0 , t_1 , and t_2 :

Before time t_0 , when the input voltage is below the UVL threshold, the unit is disabled by the Input Under-Voltage Lockout feature. When the input voltage rises above the UVL threshold, the Input Under-Voltage Lockout is released, and a Startup Inhibit Period is initiated. At the end of this delay, the ON/OFF pin is evaluated, and since it is active, the unit turns on.

At time t_1 , the unit is disabled by the ON/OFF pin, and it cannot be enabled again until the Startup Inhibit Period has elapsed.

When the ON/OFF pin goes high after t_2 , the Startup Inhibit Period has elapsed, and the output turns on within the typical Turn-On Time.



Figure F: Startup Inhibit Period (turn-on time not to scale)

